



 User Guide for the Polycom®
SoundPoint IP® 550/560 Phone
for 8x8 Virtual Office

Trademark Information

POLYCOM®, the Polycom “Triangles” logo and the names and marks associated with Polycom’s products are trademarks and/or service marks of Polycom, Inc. and are registered and/or common law marks in the United States and various other countries. All other trademarks are property of their respective owners. No portion hereof may be reproduced or transmitted in any form or by any means, for any purpose other than the recipient’s personal use, without the express written permission of Polycom.

Patent Information

The accompanying product is protected by one or more U.S. and foreign patents and/or pending patent applications held by Polycom, Inc.

Disclaimer

Some countries, states, or provinces do not allow the exclusion or limitation of implied warranties or the limitation of incidental or consequential damages for certain products supplied to consumers, or the limitation of liability for personal injury, so the above limitations and exclusions may be limited in their application to you. When the implied warranties are not allowed to be excluded in their entirety, they will be limited to the duration of the applicable written warranty. This warranty gives you specific legal rights which may vary depending on local law.

Copyright Notice

Portions of the software contained in this product are:

Copyright © 1998, 1999, 2000 Thai Open Source Software Center Ltd. and Clark Cooper

Copyright © 1998 by the Massachusetts Institute of Technology

Copyright © 1998-2003 The OpenSSL Project

Copyright © 1995-1998 Eric Young (eay@cryptsoft.com). All rights reserved

Copyright © 1995-2002 Jean-Loup Gailly and Mark Adler

Copyright © 1996-2004, Daniel Stenberg, <daniel@haxx.se>

Permission is hereby granted, free of charge, to any person obtaining a copy of this software and associated documentation files (the “Software”), to deal in the Software without restriction, including without limitation the rights to use, copy, modify, merge, publish, distribute, sublicense, and/or sell copies of the Software, and to permit persons to whom the Software is furnished to do so, subject to the following conditions:

The above copyright notice and this permission notice shall be included in all copies or substantial portions of the Software.

THE SOFTWARE IS PROVIDED “AS IS”, WITHOUT WARRANTY OF ANY KIND, EXPRESS OR IMPLIED, INCLUDING BUT NOT LIMITED TO THE WARRANTIES OF MERCHANTABILITY, FITNESS FOR A PARTICULAR PURPOSE AND NONINFRINGEMENT. IN NO EVENT SHALL THE AUTHORS OR COPYRIGHT HOLDERS BE LIABLE FOR ANY CLAIM, DAMAGES OR OTHER LIABILITY, WHETHER IN AN ACTION OF CONTRACT, TORT OR OTHERWISE, ARISING FROM, OUT OF OR IN CONNECTION WITH THE SOFTWARE OR THE USE OR OTHER DEALINGS IN THE SOFTWARE.

© 2009 Polycom, Inc. All rights reserved.

Polycom, Inc.

4750 Willow Road

Pleasanton, CA 94588-2708

USA

No part of this document may be reproduced or transmitted in any form or by any means, electronic or mechanical, for any purpose, without the express written permission of Polycom, Inc. Under the law, reproducing includes translating into another language or format.

As between the parties, Polycom, Inc., retains title to and ownership of all proprietary rights with respect to the software contained within its products. The software is protected by United States copyright laws and international treaty provision. Therefore, you must treat the software like any other copyrighted material (e.g., a book or sound recording).

Every effort has been made to ensure that the information in this manual is accurate. Polycom, Inc., is not responsible for printing or clerical errors. Information in this document is subject to change without notice.

About This Guide

Thank you for choosing the SoundPoint IP 550/560 phone, a full-duplex, hands-free SIP desktop phone. This unit provides business telephony features and functions such as multiple call appearances, call hold, transfer, and conference over an IP network.

This guide provides everything you need to quickly use your new phone. Be sure to verify with your system administrator that your network is prepared for configuring your SoundPoint IP 550/560 phone. As well, be sure to read the [Parts List](#) and [Regulatory Notices](#) sections in this guide before you set up and use the SoundPoint IP 550/560 phone. You can also find this information at <http://www.8x8.com/Support.aspx>.

Contents

About This Guide	iii
1 Getting Started with Your Phone	1-1
Parts List	1-2
Assembling Your Phone	1-3
Connecting Network and Power Source	1-4
Connecting the Handset and Optional Headset	1-7
Attaching the Base	1-7
Registering Your Phone	1-10
Features of Your Phone	1-10
Before You Use Your Phone	1-15
Using the Navigation Keys	1-15
Information Status	1-16
2 Customizing Your Phone	2-1
Configuring Basic Settings	2-2
Changing the Appearance of Time and Date	2-2
Changing the Display Contrast	2-3
Changing the Backlight Intensity	2-4
Enabling the Headset Memory Mode	2-6
Selecting the Correct Headset for Electronic Hookswitch	2-7
Selecting the Ring Type	2-8
Changing the Language	2-8
Changing the Graphic Display Background	2-9
Changing the Soft Key Label Color	2-10
Muting the Microphone	2-11
Adjusting the Volume	2-11
Managing Call Lists	2-12
Managing Contacts	2-13
Adding Contacts	2-14

Editing Contacts	2-17
Deleting Contacts	2-18
Placing Calls to Contacts	2-18
Searching for Contacts	2-19
Managing Incoming Calls	2-22
Distinguishing Calls	2-22
Rejecting Calls	2-23
Diverting Calls	2-24
System Customizations	2-24
Supporting Multiple Lines	2-24
Supporting Multiple Line Keys Per Line	2-25
Supporting Shared Lines	2-26
3 Using the Features of Your Phone	3-1
Placing Calls	3-2
Answering Calls	3-4
Ending Calls	3-8
Redialing Numbers	3-8
Hosting Local Conference Calls	3-8
Setting Up Conference Calls	3-9
Splitting Conference Calls	3-11
Ending Conference Calls	3-11
Using Conference Bridges	3-11
Transferring Calls	3-12
Forwarding Calls	3-14
Online Call Forwarding	3-15
Phone-based Call Forwarding	3-15
Enabling Do Not Disturb	3-17
Placing Calls on Hold	3-19
Returning the Last Call	3-20
Using the Intercom	3-20
Using the Auto Attendant	3-20
Parking a Call	3-20
Using the Corporate Directory	3-21
Using Call Lists	3-21
Using voicemail	3-22
Recording Calls (Virtual Office Pro Users Only)	3-23
Using Call Queues (Call Queue Users Only)	3-23
Assigning Speed Dial Keys	3-23

4 Troubleshooting Your Phone	4-1
Power and Startup	4-2
Controls	4-3
Access to Screens and Systems	4-4
Calling	4-5
Displays	4-7
Audio	4-8
Testing Phone Hardware	4-9

Getting Started with Your Phone

This chapter provides basic installation instructions and information for obtaining the best performance with the SoundPoint IP 550/560 desktop phone.

The SoundPoint IP 550/560 provides a powerful, yet flexible IP communications solution, delivering excellent voice quality. The high-resolution graphic display supplies content for call information, multiple languages, directory access, and system status. The SoundPoint IP 550/560 supports advanced functionality, including multiple call and flexible line appearances, HTTPS secure provisioning, presence, custom ring tones, local conferencing, applications, and Polycom® HD™ Voice technology.

Powered by state of the art Gigabit Ethernet IP telephony technology, the SoundPoint IP 560 features a future-proof dual-port Gigabit Ethernet switch for seamless integration with a computer or desktop server. For organizations with existing GigE deployment, the SoundPoint IP 560 delivers unobstructed, high-speed access to data and productivity-boosting data and applications. For organizations with plans to migrate to GigE, the SoundPoint IP 560 protects investment in desktop networking.

This chapter contains:

- [Parts List](#)
- [Assembling Your Phone](#)
- [Registering Your Phone](#)
- [Features of Your Phone](#)
- [Before You Use Your Phone](#)

To customize your phone, refer to [Customizing Your Phone](#) on page 1-1. To read about the phone's basic features, refer to [Using the Features of Your Phone](#) on page 3-1.

If you require additional information or assistance with your new phone, contact your system administrator.

Parts List

The following components are included in your SoundPoint IP 550/560 package:

- Polycom SoundPoint IP 550/560 phone

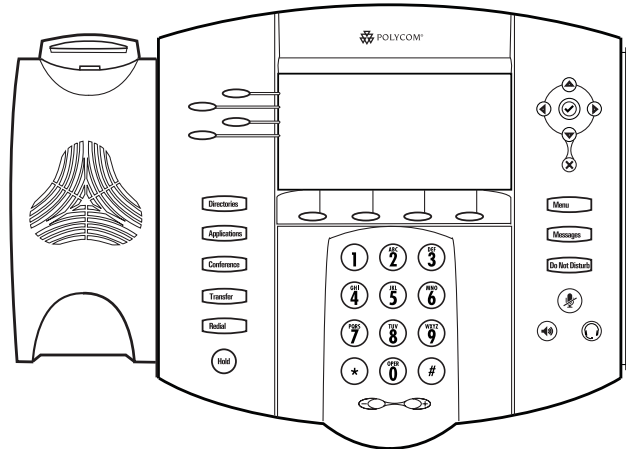

- Handset and Handset cord

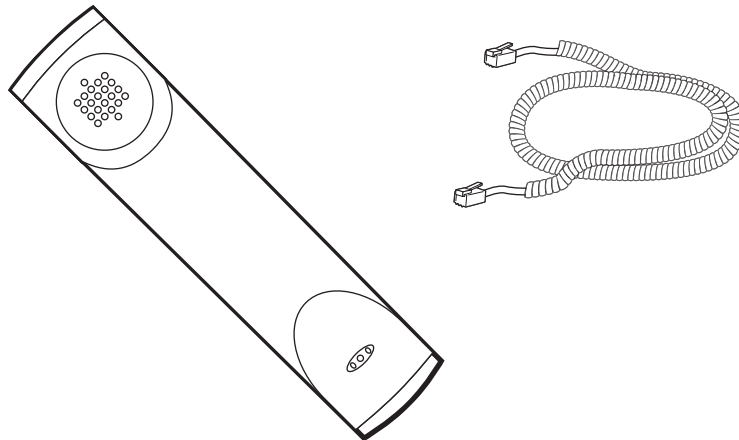

- Phone Base

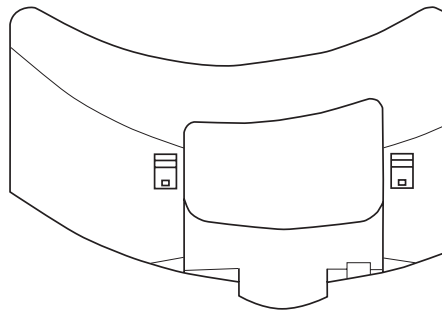

- Network / Power Cable

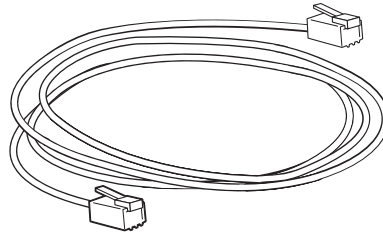

- Quick Start Guide and registration card

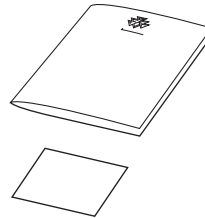

Check this list before installation to ensure that you have received each item. If you are missing any items, contact your system administrator.

Assembling Your Phone

This section describes how to assemble your SoundPoint IP 550/560 phone:

- Connect network and power source
- Connect handset and headset (optional)
- Attach phone base

If your phone is already assembled, go directly to [Features of Your Phone](#) on page 1-10.

Connecting Network and Power Source

You have two options for network and power source connections. Your system administrator will advise you on which one to use.

You can use one of the following methods:

- AC power
- Power over Ethernet (PoE)

AC Power

To connect the AC power:

1. Connect the supplied network cable between the LAN jack on the phone and the LAN port on the wall or hub/switch device port.
2. Connect the DC plug on the power adapter to the DC 24V jack marked on the SoundPoint IP 550 phone or DC48V jack marked on the SoundPoint IP 560 phone.

3. Connect the country-specific AC cord to the power adapter.

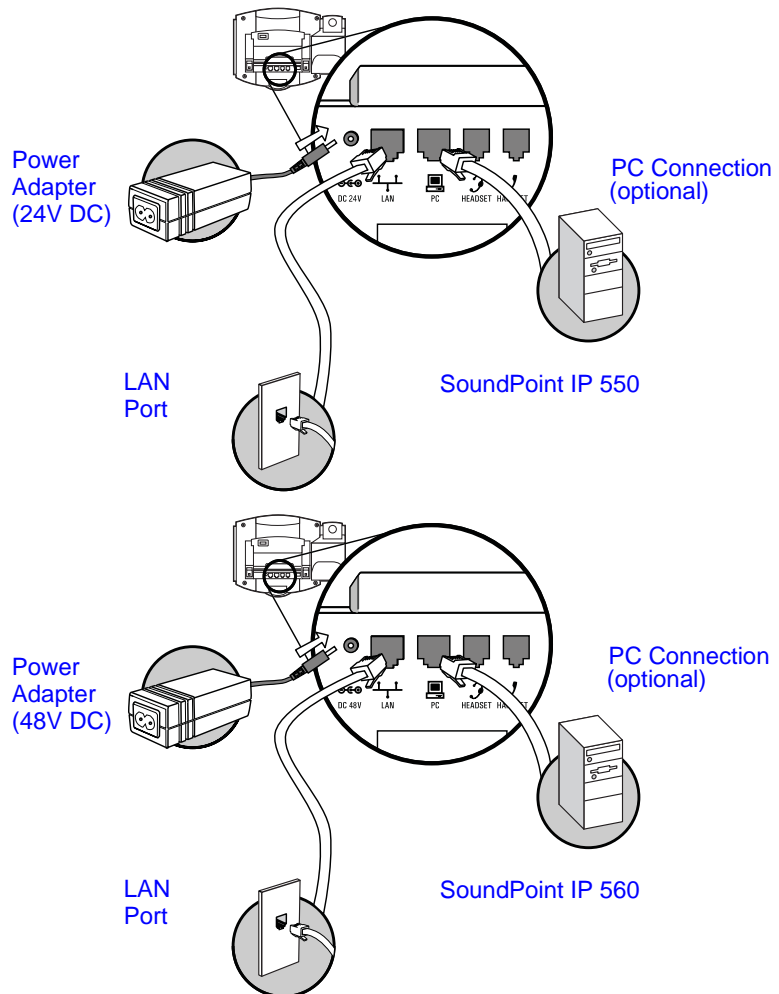

Power over Ethernet

Using a regular CAT5 cable, the phone can be powered from a PoE (IEEE 802.3af) compliant switch or hub.

To connect the PoE:

- Plug the supplied network cable between the LAN jack on the phone and an available power and data port on the in-line power switch.

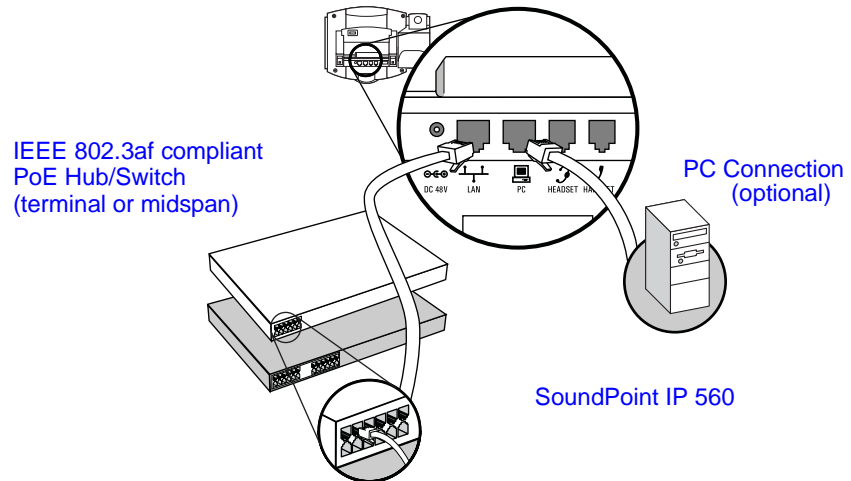
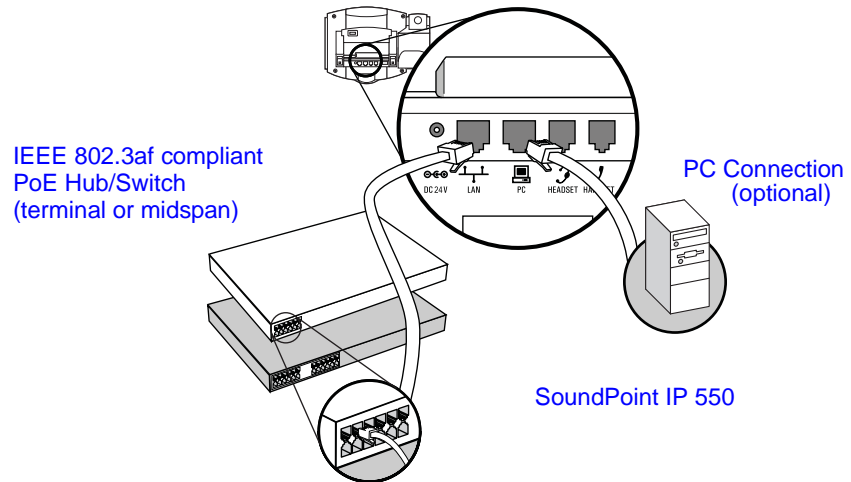

Connecting the Handset and Optional Headset

To connect the handset and optional headset:

1. Connect the short straight end of the phone cord to the handset and the corresponding longer straight end of the cord to the handset jack on the back of the phone.
2. Connect the headset (optional) to the headset jack on the back of the phone.

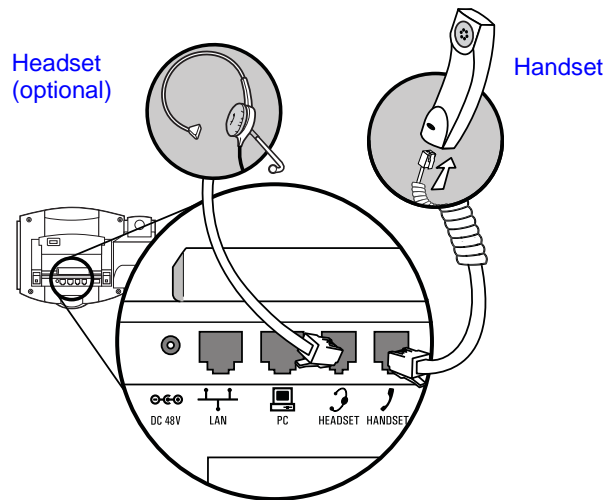

For information on supported headsets, go to http://www.polycom.com/support/voice/soundpoint_ip/VoIP_Technical_Bulletins_public.html and look for "Technical Bulletin 37477: Headset Compatibility List".

Attaching the Base

The phone base can be attached to the SoundPoint IP 550/560 in one of two ways:

- As a desk mount
- As a wall mount

To attach the base as a desk mount:

1. Place all cords in the recessed area above the modular jacks.

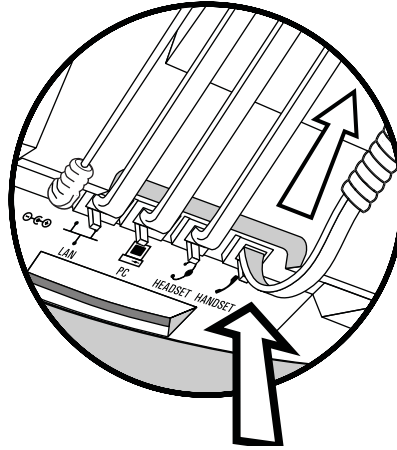

2. Align the two protrusions on the bracket with their corresponding holes in the phone.

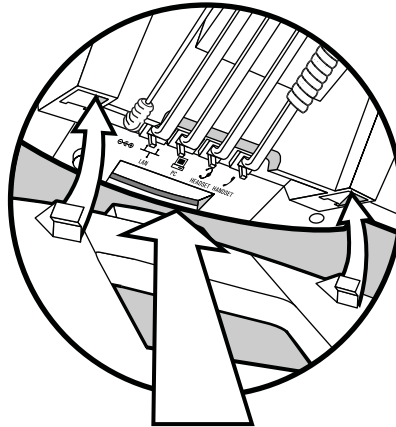

3. Snap them together to lock the base to the phone.

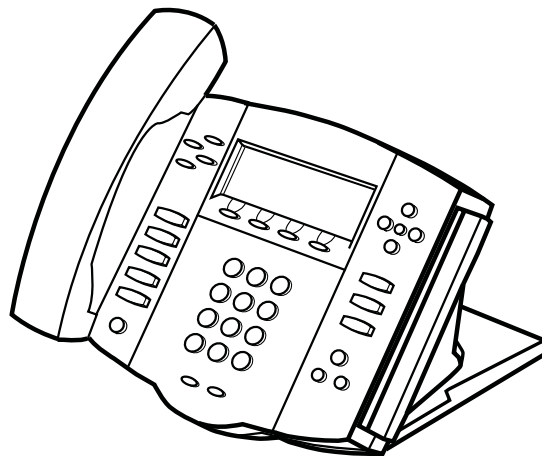

To attach the base as a wall mount:

1. Place all cords in the recessed area above the modular jacks.

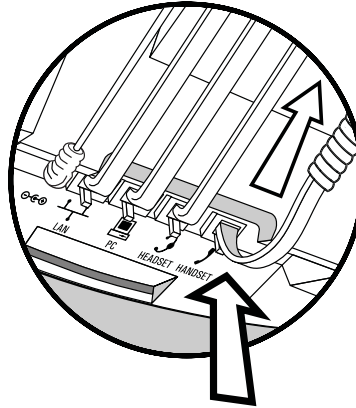

2. On the back of the phone, remove the key located behind the hookswitch and reposition it so that the end tab (at a 45° angle) is facing up.

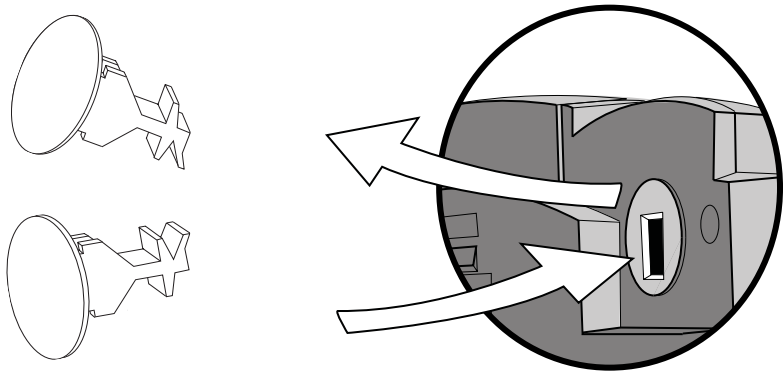

3. With the base unit facing up, fasten it to the wall mount using wall anchors.

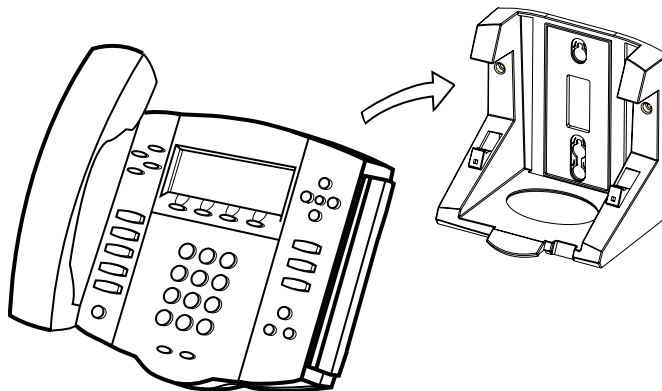

Note

The wall mount is not included in SoundPoint IP 550/560 package. Contact your system administrator if you require one.

Registering Your Phone







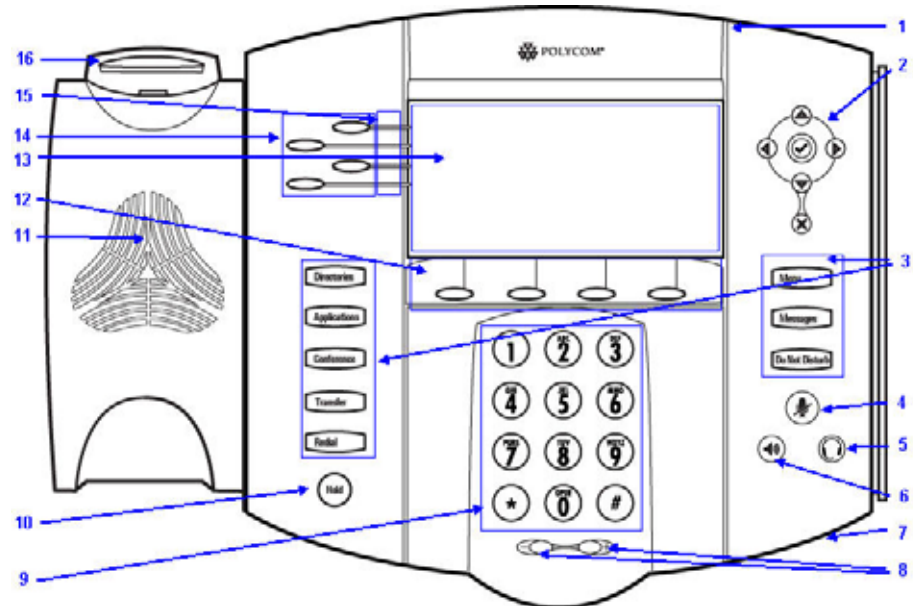









Generally, your phone will be deployed with multiple other phones. In this case, your system administrator will configure the phone parameters beforehand, so that after you set up your phone, the phone will be registered and ready to use.



If your phone is not part of a large phone deployment, your phone may not be registered after you set it up. Before you use your phone, you or your system administrator will have to register it. For detailed information on how to register your phone after you install it, refer to “Quick Tip 44011: Registering Standalone SoundPoint IP, SoundStation IP, and Polycom VVX Phones” at http://www.polycom.com/usa/en/support/voice/soundpoint_ip/VoIP_Technical_Bulletins_pub.html.

Features of Your Phone















The features of your SoundPoint IP 550/560 phone are:

	Item	Description
1	Message Waiting Indicator	Alert for voice and text (instant) messages.
2	Arrow Keys	
	 	Scroll through displayed information.
	 	
		Select a field of displayed data.
		Delete displayed data.
3	Feature Keys	Access important features using these keys.
		Access to local directories and call lists.
		Access to special applications (contact system administrator).
		Allows connection with multiple other parties for a conference.
		Transfer of current call to third party.
		Dials most recently dialed party.
		Access local (your phone) and global (your organization) features.
		Access and manage text and voice messages.
		Cancels ringing and directs incoming calls to your voicemail (if supported).
4	Microphone Mute 	Mutes audio transmission locally during calls and conferences.
5	Headset 	Allows you to place and receive calls through an optionally connected headset.

	Item	Description
6	Speakerphone 	Allows for hands-free communication during calls.
7	Hands-free Microphone	Picks up audio during hands-free calls. Place your phone on a hard, flat surface for best results.
8	Volume Keys 	Adjusts the volume of the handset, headset, speaker, and ringer.
9	Dial Pad	Provides the 10 digits, the alphabetic characters, and special characters available in context-sensitive applications.
10	Hold 	Holds an active call or resumes a held call.
11	Speaker	For ringer and hands-free audio output.
12	Soft Keys	These keys are automatically labeled to identify their context-sensitive functions.
13	Graphic Display	Shows information about calls, messages, soft keys, time, date, and other relevant data. <ul style="list-style-type: none"> • Caller display information—first party, second party, number of calls • Information status line <ul style="list-style-type: none"> • Popup text (for example, network errors) • Do Not Disturb text • Missed call text or second incoming caller display • Prompt text (for example, “Enter number”) • Time and date text (if idle display is not used for time/date display) <p>Associated line icons are described in the following table.</p>

	Item	Description
14	Line/Speed Dial Key 	Use these keys to activate up to four lines or speed dials that can be assigned to your phone.
15	Line Indicators	Individual multi-color LEDs display the dynamic call state and remote user status (busy lamp field (BLF) and presence). The mapping is: <ul style="list-style-type: none">• Solid green—An active call is in progress.• Fast flashing green—There is an incoming (ringing) call.• Flashing green—The call is held by the other party.• Flashing red—The call is on hold.• Solid red—The line is busy remotely (shared lines)
16	Hookswitch	

Icons associated with the line keys appear on the graphic display and represent:

Icon	Description
	Registered line (solid)
	Registered shared line
	Unregistered line (outline)
	voicemail/Text messages
	Speed dial
	Ringing
	Call in progress with HD Voice
	Call in progress
	Call Forward
	Do Not Disturb
	Conference
	Presence/Busy Lamp Field (BLF)









Before You Use Your Phone

Note

The background and key colors that appear on your SoundPoint IP 550/560 phone may differ from the screenshots that appear in this user guide.

Using the Navigation Keys

To help you navigate menus and enter data, use these tips:

- To scroll through lists, use  and  or hold down  and .
- Press the * key to page up. Press the # key to page down. Use these shortcuts when lists appear on more than one page.
- To move one level down and one level up when menus have submenus, use  and .
- To exit from any menu, press .
- To exit from any directory, press .
- Use the dial pad keys to navigate through and make selections in numbered menu lists.
- To enter text using the dial pad, press the number keys one or more times. For example, for 'A' press 2 and for 'C' press 222. When in text entry mode, the title will show whether keys will generate digits (1), upper-case (A), or lower-case (a) characters— use the **1/A/a** soft key to change—and whether keys will generate ASCII, Latin, Cyrillic, Katakana, or Unicode characters—use the **Encoding** soft key to change.

Information Status

The top line of the screen (or graphic display) shows status information. It appears as a scrolling list if there is more than one message. The number of messages in the list also appears. In order of precedence from highest to lowest, the messages are:

- Popup text (for example, network errors)
- Do Not Disturb text
- Missed call text or second incoming caller display
- Prompt text (for example, "Enter number")
- Time and date text

The following figures provide some examples:

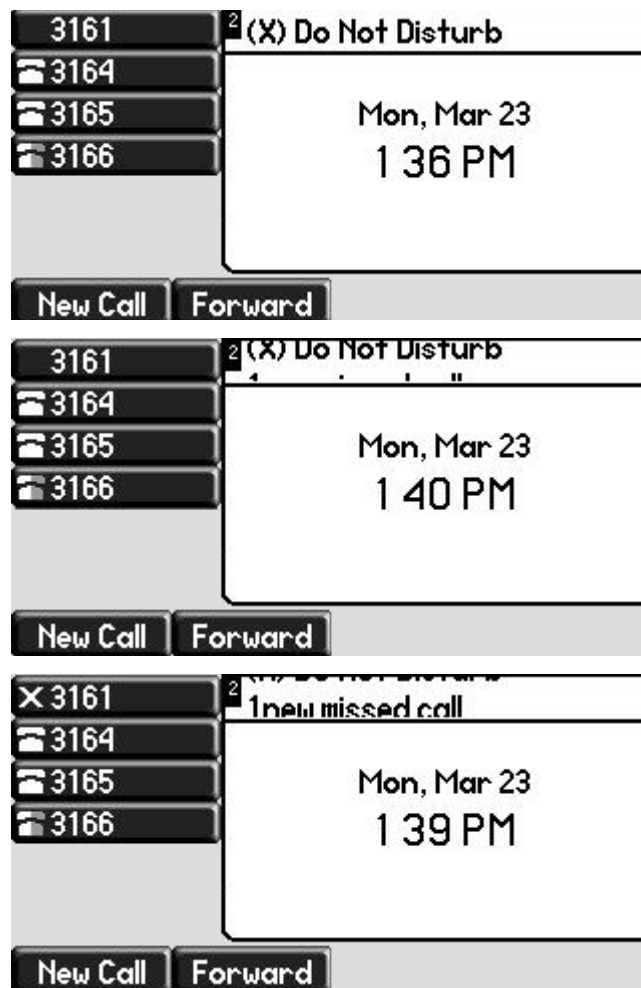

Customizing Your Phone

You can customize your SoundPoint IP 550/560 desktop phone by adjusting the setting for time and date, display contrast, and ring type, for example. You can add contacts to the phone's directory manually or from call lists. You can handle incoming calls from different contacts in different ways.

This chapter provides basic operating instructions for customizing your SoundPoint IP 550/560 phone. This chapter contains:

- [Configuring Basic Settings](#)
- [Managing Call Lists](#)
- [Managing Contacts](#)
- [Managing Incoming Calls](#)

Some customizations of your SoundPoint IP 550/560 phone are performed by your system administrator. These include:

- [Supporting Multiple Lines](#)
- [Supporting Multiple Line Keys Per Line](#)
- [Supporting Shared Lines](#)

To read about the phone's basic features, refer to [Using the Features of Your Phone](#) on page 3-1.

If you require additional information or assistance with your new phone, contact your system administrator.

Configuring Basic Settings

You can configure the following basic settings through use of  :

- Appearance of the time and date
- Display contrast
- Backlight intensity
- Headset Memory Mode
- Headset hookswitch selection
- Ring type
- Language support (localization)
- Background pattern
- Soft key label color

You can mute the microphone and adjust the volume using separate keys.

Changing the Appearance of Time and Date

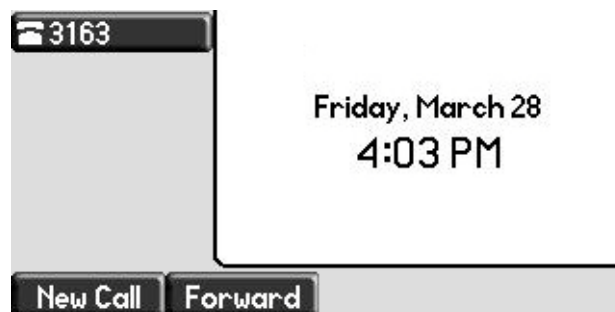

The time and date appears on the graphic display of the SoundPoint IP 550/560 phone. If the phone cannot obtain a time and date from the call server, the display will flash. Contact your system administrator if either the time or date is incorrect.

You can select from various formats for the time and date display. Select and set options that are right for you. You can also disable the time and date display, so the time and date do not display on the phone screen.





To configure the time and date formats:

1. Press .
2. Select **Settings > Basic > Preferences > Time & Date**.

3. Select from **Clock Date**, **Clock Time**, **Clock Order**, or **Enable/Disable**.
4. Using  and , scroll through the options under each of these selections.
5. Press the **Select** soft key or  to confirm your choice.

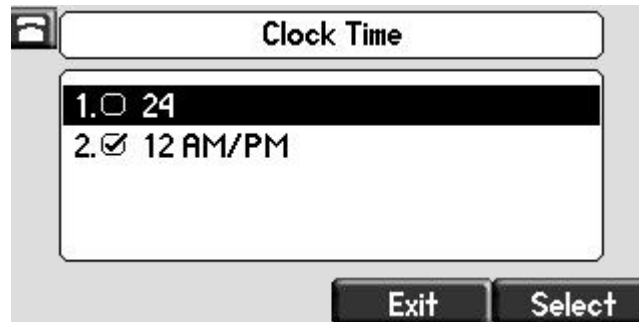
The following figure shows the Clock Time menu.



6. Press  to return to the idle display.

Changing the Display Contrast

To adjust the contrast on the display to a comfortable level:

1. Press .
2. Select **Settings > Basic > Contrast**.

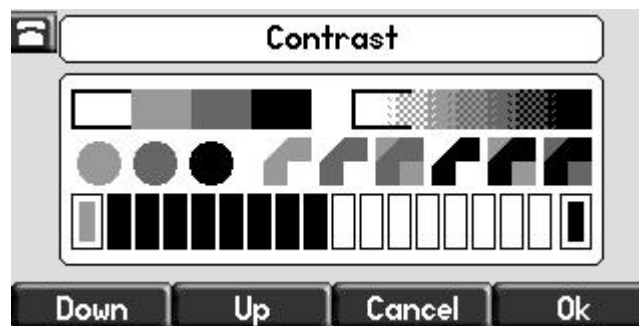

3. Press the **Up** or **Down** soft keys to increase or decrease the display contrast.

Note

You can also use the volume keys to increase or decrease the display contrast.

4. Press the **Ok** or **Cancel** soft keys to accept or cancel changes.
5. Press  to return to the idle display.

Changing the Backlight Intensity

Backlight intensity on the SoundPoint IP 550/560 phone has three components:

- Backlight On
- Backlight Idle
- Maximum Intensity

You can modify the Backlight On intensity and the Backlight Idle intensity separately. You can select high, medium, low, and off levels for both.

When you modify the Maximum Intensity, you are modifying the entire backlight intensity scale. For example, if you decrease the Maximum Intensity, the low, medium, and high values for both Backlight On intensity and the Backlight Idle intensity decrease.

The Backlight On intensity applies for the following events:

- Any key press
- Hookswitch release
- Incoming calls
- Ending a call, holding a call, resuming a call by the other party
- A voice or instant message received

If you do not press any keys on the phone after 20 seconds of the backlight turning on, the backlight dims (or changes) to medium in the following cases:



- A call is in progress
- A call is on hold
- There is an incoming call (ringing)
- There is an outgoing call (ringing back)
- Any menu shows on the display

In all other cases, the Backlight Idle intensity applies.



To modify the backlight intensity:

1. Press .
2. Select **Settings > Basic > Backlight Intensity**.
3. Select **Backlight On Intensity**.





4. Use  or  or keypad to select high, medium, low, or off, and then press the **Select** soft key.
The default level is medium.
5. Select **Backlight Idle Intensity**.

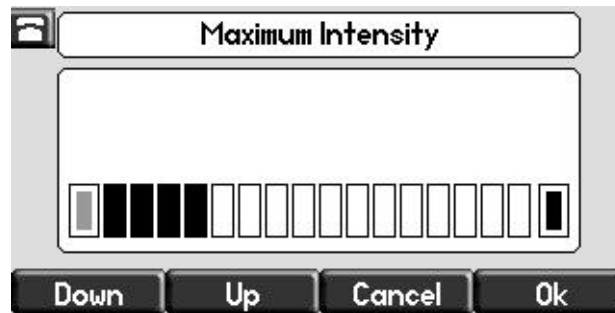

6. Use  or  or keypad to select high, medium, low, or off, and then press the **Select** soft key.
The default level is low.

7. Select **Maximum Intensity**.





8. Press the **Up** or **Down** soft keys to increase or decrease the backlight intensity.
9. Press the **Ok** or **Cancel** soft keys to accept or cancel changes.
10. Press  to return to the idle display.

Enabling the Headset Memory Mode

This feature is especially useful for permanent or full-time headset users.

To permanently enable the Headset Memory Mode:

1. Press .
2. Select **Settings > Basic > Preferences > Headset... > Headset Memory...**
3. Use  or  to select **Enabled**, and then press the **Select** soft key.

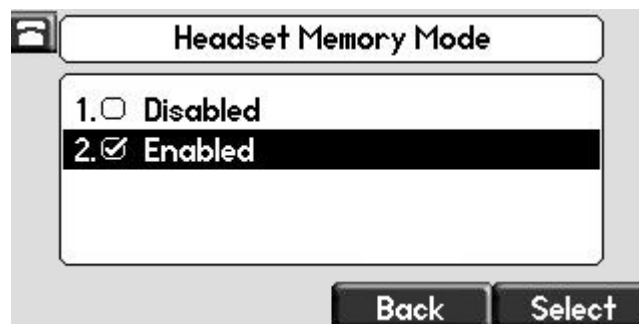

4. Press  to return to the idle display.

Repeat steps 1 to 4 to select **Disabled** and turn Headset Memory Mode off.

To activate Headset Memory Mode:

>> Press  twice.

The flashing headset icon on the graphic display or a flashing headset key indicates that the headset mode is activated. Pressing  or the **Answer** soft key to receive a call will now connect to your headset automatically.



Selecting the Correct Headset for Electronic Hookswitch

This feature allows you to answer your phone when you are using a headset.



For information on supported headsets to provide electronic hookswitch features for placing, answering, and ending calls, go to www.polycom.com/support/voice and enter "Headset Compatibility List" in the Knowledge Base text box or contact your system administrator.

To select a headset that supports electronic hookswitch:

1. Press .
2. Select **Settings > Basic > Preferences > Headset > Analog Headset Mode**.
3. Use  or  to select your headset, and then press the **Select** soft key.

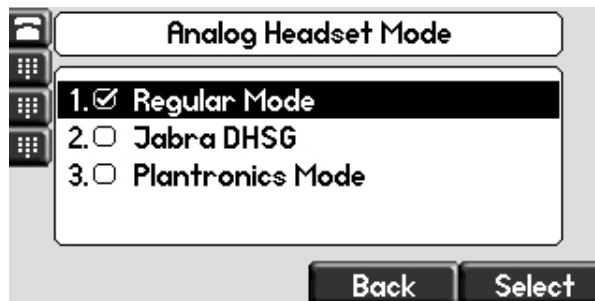





4. Press  to return to the idle display.

Selecting the Ring Type

You can select different ring types to distinguish lines or to distinguish your phone from your neighbor's phone.

To change the incoming ring type:

1. Press .
2. Select **Settings > Basic > Ring Type**.
3. (Optional.) If multiple lines are configured on your phone, first select the line to change from the list using the  and .
4. Use  and  to select the desired ring type.

To hear the selected ring type, press the **Play** soft key.



5. Press the **Select** soft key to change to the selected ring type.
6. Press  to return to the idle display.

Note

If you configure your SoundPoint IP 550/560 phone with a silent ring, press the flashing Line key or the **Answer** soft key to answer the call. If your handset is off hook, the call is routed to the handset. If your handset is on hook, the call is routed to the speaker.

Changing the Language

Many languages are supported by the SoundPoint IP 550/560 phone.

To change the language:

1. Press .
2. Select **Settings > Basic > Preferences > Language**.

3. Use  and  to highlight the language you want.



4. Press the **Select** soft key.

Text that appears on the graphic display will change to the language of your choice.

5. Press  to return to the idle display.

Changing the Graphic Display Background

You can change the picture or design that appears on the graphic display. A default background displays when the phone starts up (shown below). For more information on selections, contact your system administrator.

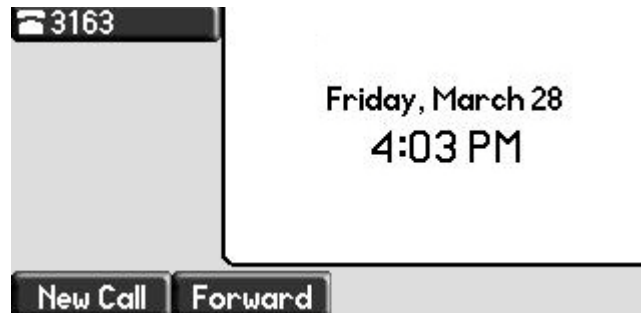

To change the graphic display background:

1. Press .
2. Select **Settings > Basic > Preferences > Backgrounds**.

Note

Under certain circumstances, you may need to make an additional menu selection, **Select Background**, to actually select the background.

If your system administrator has configured the phone's idle browser and you want to view the background and not the idle browser, you can turn off the idle browser by doing the following:

- Select **Background > Prioritize Background**.
- Select **Enable** and press the **Select** soft key.

3. Use  and  to highlight the background you want.



4. Press the **Select** soft key.
5. Press  to return to the idle display.

Changing the Soft Key Label Color

You can change the soft key label color that appears on the graphic display. A default soft key label color displays when the phone starts up (shown below). For more information on selections, contact your system administrator.

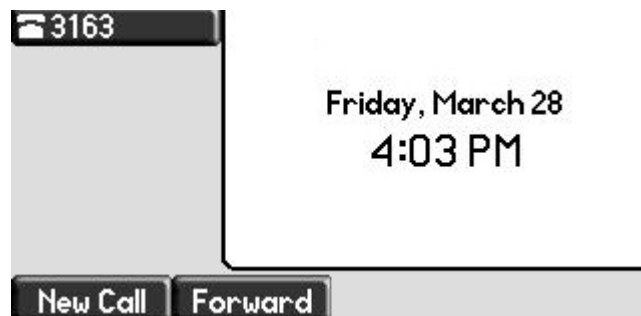

To change the soft key label color:

1. Press  .

2. Select **Settings > Basic > Preferences > Label Color**.

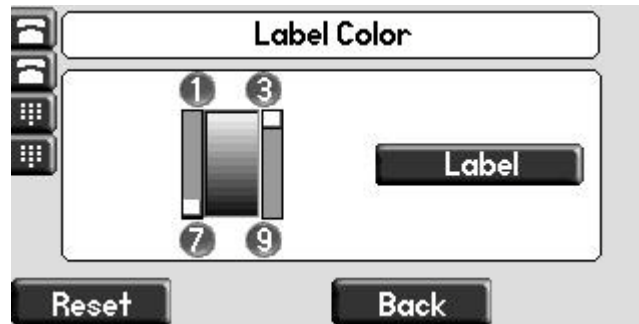

Using the dialpad keys 1, 3, 7, and 9 change the soft key color to your desired color. The **Label** soft key on the right reflects your changes.

Note

When the color of the label reaches a certain level of whiteness, "Cannot save this color. Text might be unreadable." appears. This popup appears only the first time the color reaches that level.

3. Press the **Save** soft key.

Press the **Reset** soft key to reset the color to the default color.

Press the **Undo** soft key to undo your last change.

4. Press  to return to the idle display.

Muting the Microphone

During a call, press . The Message Waiting Indicator turns red indicating that the other party (or parties) cannot hear you.

Microphone Mute applies to all modes: Handset, Headset, and Hands-free Speakerphone. You can still hear all other parties while mute is enabled.

To turn off Microphone Mute, press  again.

Adjusting the Volume

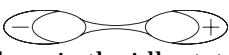
Press  to adjust receiver volume during a call. Pressing these keys in the idle state adjusts the ringer volume.

Note

Handset volume will return to a preset level after each call. Headset and hands-free (speakerphone) volume will be remembered after each call. This configuration can be changed by 8x8 Support.

Managing Call Lists

Your phone maintains local lists of missed, received, and placed calls. Each list contains 100 entries.

Press **Directories** followed by **Call Lists > Missed Calls, Received Calls, or Placed Calls**. The following shows a Placed Calls list.



Manage the call list by doing the following:

- To edit the phone number, press the **Edit** soft key.
- To return the call, press the **Dial** soft key.
- To view information about the call, press the **More** soft key followed by the **Info** soft key.
- To store the contact in the Contact Directory, press the **More** soft key followed by the **Save** soft key.
- To delete the call from the list, press the **More** soft key followed by the **Clear** soft key.

Press **Directories** to return to the idle display.

Note

Press the **Right** arrow key from the idle display to access the Placed Calls list. Press the **Left** arrow key from the idle display to access the Received Calls list. Press the **Down** arrow from the idle display to access the Missed Calls list. You can use these shortcuts while placing calls or performing transferring and conferencing functions.

Note

You can manually clear all call lists. They are automatically cleared when you restart the phone.

Managing Contacts

You can store a large number of contacts in your phone's directory. Contact your system administrator for the exact number.

You can add, edit, delete, dial, or search for a contact in this directory.



You may have read access to portions of your corporate directory through your phone. The contacts that you can see are determined by your system administrator. You can add contacts from the corporate directory to your local contact directory.

Adding Contacts

You can add contacts to your contact directory:

- Manually
- From a call list
- From your corporate directory

Adding Contacts Manually

To add a contact to the local contact directory manually:

1. Press  .
2. Select **Contact Directory**.
3. Press the **More** soft key.
4. Press the **Add** soft key.
5. Enter first and/or last name of the contact from the keypad.

Use the **1/A/a** soft key to select between numeric and upper/lower case alphanumeric modes.

Use the **Encoding** soft key to access special characters in other languages.



6. Enter a contact number.
This is a required field and it must be unique (not already in the directory).

7. (Optional.) Change the Speed Dial Index.

It is automatically assigned to the next available index value.

Valid speed dial index values are from 1 to 9999. If you enter a speed dial index that already exists, “Speed dial index already exists” appears. If you enter an invalid value, “Speed dial index invalid” appears.

For more information, refer to [Assigning Speed Dial Keys](#) on page 3-23.



8. (Optional.) Change the Ring Type and Divert Contact.

These fields may be left blank.

For more information on setting the Ring Type field, refer to [Distinguishing Calls](#) on page 2-22.

For more information on diverting contacts, refer to [Diverting Calls](#) on page 2-24.

9. (Optional.) Change the Auto Reject, Auto Divert, Watch Buddy, and Block Buddy.

Use  and  to switch between Enabled and Disabled settings.

For more information on setting the Auto Reject field, refer to [Rejecting Calls](#) on page 2-23.





10. Press the **Save** or **Cancel** soft keys to accept or cancel changes.



11. Press  to return to the idle display.

Adding Contacts From Call Lists

To add a contact to the local contact directory from a call list:

1. Do one of the following:

- a Press , and then select **Call Lists >Missed Calls**, **Received Calls**, or **Placed Calls** as desired.
- b Press , , or  to access the desired call list.

- Use  and  to highlight the contact.

You can also use the * key to Page Up and the # key to Page Down.

- Press the **More** soft key, and then the **Save** soft key to save the contact in the phone's directory.



- Press  to return to the idle display.

Note

You may want to go to the local contact directory to check if the contact was saved correctly, and to add any missing fields.

Adding Contacts From the Corporate Directory

To add a contact to your local contact directory from the corporate directory:

- Press .
- Select **Corporate Directory**.
- Search for the contact.
Refer to [Searching the Corporate Directory](#) on page 2-20.
- Press the **View** soft key.



The contact's information appears on the graphic display.



5. Press the **Save** soft key to save the contact in the local contact directory.
 “Entry saved” appears on the graphic display. Only the first name, last name, and phone number are saved.
 If the contact already exists in the contact directory, “Entry already exists” appears.
6. Press  to return to the idle display.

Editing Contacts

To edit a contact in the local contact directory:

1. Press .
2. Select **Contact Directory**.
3. Use  and  to highlight the contact.
 You can also use the * key to page up and the # key to page down.
4. Press the **Edit** soft key
5. Edit the contact information.







6. Press the **Save** or **Cancel** soft keys to accept or cancel changes.
7. Press  to return to the idle display.

Note

You can quickly edit a contact associated with a speed dial key by pressing and holding the contact's speed dial key, and then complete steps 5 to 7.

Deleting Contacts



To delete a contact from the local contact directory:

1. Press .
2. Select **Contact Directory**.
3. Use  and  to highlight the contact.
You can also use the * key to page up and the # key to page down.
4. Press the **More** soft key twice, and then press the **Delete** soft key.
The contact is deleted from the directory.
5. Press  to return to the idle display.

Placing Calls to Contacts

Placing Calls From the Contact Directory

To place a call to a contact in the local contact directory:

1. Press .
2. Select **Contact Directory**.
3. Use  and  to highlight the contact.
You can also use the * key to page up and the # key to page down.
4. Press the **Dial** soft key.

Placing Calls From the Corporate Directory

To place a call to a contact in the corporate directory:

1. Press .
2. Select **Corporate Directory**.
3. Search for the contact.
Refer to [Searching the Corporate Directory](#) on page 2-20.

4. Press the **View** soft key.

The contact's information appears on the graphic display.



5. Press the **Dial** soft key.

Searching for Contacts

Searching the Contact Directory

To search for a contact in the local contact directory:

1. Press **Directories**.
2. Select **Contact Directory**.
3. Press the **More** soft key, and then the **Search** soft key.
4. Using the dial pad, enter the first few characters of the contacts's first or last name.



5. Press the **Search** soft key again.

You can dial any successful matches from the resulting information on the graphic display.

Searching the Corporate Directory

To search for a contact in the corporate directory:

1. Press .
2. Select **Corporate Directory**.

Note

You can enable your phone to save Corporate Directory search results, and to remember the last person you viewed in the directory. Whenever you redisplay Corporate Directory, the last person you viewed will display. If you searched for a person, the results of the last search you submitted will display. To enable this feature, press the **Menu** key, and then select **Settings > Basic > Preferences > Corporate Directory > View Persistency**. Select **Enabled**, press the **Select** soft key, and then press the **Menu** key to exit the menu.

3. Search for the contact in one of the following ways:
 - In the search line, enter the first few characters of the contacts last name using the dial pad. For example, to search for Carol Woller, enter **wo** in the search line.



Press the **Submit** soft key. In this example, Carol Woller appears in the search results.



If no entries in the corporate directory match the search parameters, “No entries found.” appears.

- Press the **AdvFind** soft key, enter search values in the displayed fields. For example, enter **Byron Smith** as the first name and last name.

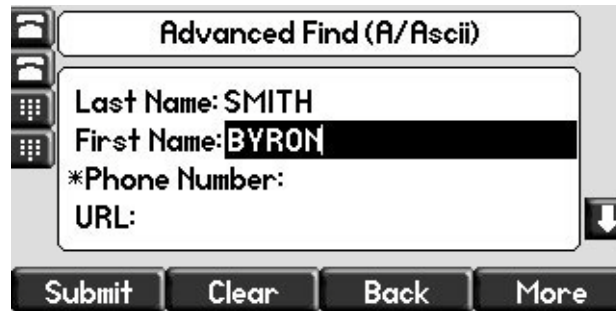

Press the **Submit** soft key. In this example, Bryon Smith appears in the search results.



You can dial any successful matches from the resulting information on the graphic display.

Managing Incoming Calls

You can distinguish incoming calls by setting distinctive rings for contacts in your contact directory, sending particular calls directly to your voicemail, or transferring particular calls to another party.

Distinguishing Calls

You can customize your phone so that you can distinguish different parties by ring type.

Note

This feature is local to the phone, and may be overridden by your organization's settings. For more information, contact your system administrator.

To set a distinctive ring type for a contact:

1. Press **Directories**.
2. Select **Contact Directory**.
3. Use **▲** and **▼** to highlight the contact.
You can also use the * key to page up and the # key to page down.
4. Press the **Edit** soft key, and then scroll down to the Ring Type field.



5. Enter the number corresponding to one of the ring types available.
For more information, refer to [Selecting the Correct Headset for Electronic Hookswitch](#) on page 2-7.
6. (Optional.) To remove an existing value, press **⊗**.
7. Press the **Save** or **Cancel** soft keys to accept or cancel changes.
8. Press **Directories** to return to the idle display.

Rejecting Calls

You can customize your phone so that incoming calls from a particular party are immediately sent to your voicemail.

Note

Rejecting calls is not available on shared lines.

To send incoming calls from a contact directly to voicemail:

1. Press **Directories**.
2. Select **Contact Directory**.
3. Use **▲** and **▼** to highlight the contact.
You can also use the * key to page up and the # key to page down.
4. Press the **Edit** soft key, and then scroll down to the Auto Reject field.



5. Use the **◀** and **▶** to select Enabled.
6. Press the **Save** or **Cancel** soft keys to accept or cancel changes.
7. Press **Directories** to return to the idle display.

Diverting Calls

You can customize your phone so that incoming calls from a particular contact are transferred directly to a third party.

To divert incoming calls from a particular contact:

1. Press **Directories**.
2. Select **Contact Directory**.
3. Use **▲** and **▼** to highlight the contact.
You can also use the * key to page up and the # key to page down.
4. Press the **Edit** soft key, and then scroll down to the Divert Contact field.



5. Enter the number of the party to whom you want to divert the call.
6. Scroll down to the Auto Divert field.
7. Use the **◀** and **▶** to select Enabled.
8. Press the **Save** or **Cancel** soft keys to accept or cancel changes.
9. Press **Directories** to return to the idle display.

System Customizations

The following section details customizations of your SoundPoint IP 550/560 phone that are performed by your system administrator.

Supporting Multiple Lines

Your SoundPoint IP 550/560 phone can support up to 8 lines.

Typically, the top-most Line Key is reserved for the principal directory number (DN) of the phone.

Depending on how your administrator sets up your phone, the display could resemble one of the following figures:

- One line, 3163



- Two lines, 3161 and 3163

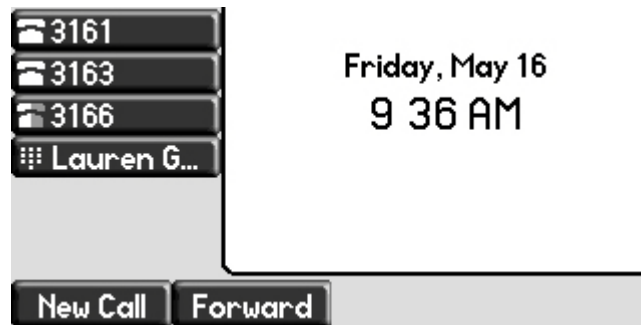

Supporting Multiple Line Keys Per Line

Each line on the phone can be configured to have more than one Line Key associated with it. This enhances call visualization and simplifies call handling. If this is the case, the display could resemble the following figure:

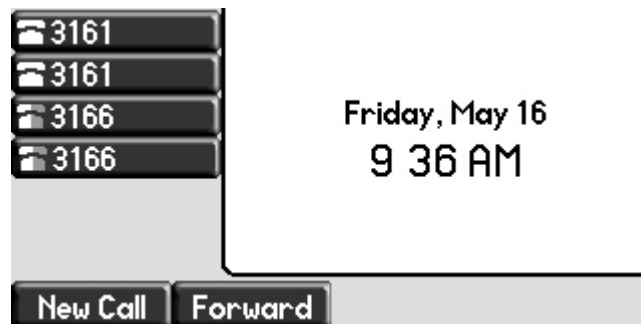

Incoming calls to this line will be distributed evenly among the available Line Keys. Similarly, outgoing calls will be distributed.

Your phone can be configured to have a combination of lines with a single Line Key and lines with multiple Line Keys.

Supporting Shared Lines

Your SoundPoint IP 550/560 supports shared lines.

Note

Shared lines are an optional feature and may not be supported on your particular system. For more information, contact your system administrator.

A shared line is indicated by a different line icon. In the following figure, the lines 3161 and 3163 are private and the line 3166 is shared.

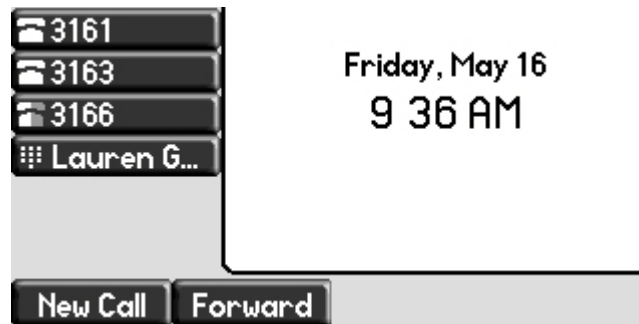

If two phones share a line, an incoming call to that number will cause both phones to ring. The call can be answered on either phone but not both.

Calls on shared lines can be transferred, put on hold, or added to a conference.

Note

Call Forwarding is not available on shared lines.

Do Not Disturb (DND) on shared lines disables the ringing option only, the visual indication is still in place.

Using the Features of Your Phone

Your SoundPoint IP 550/560 desktop phone is designed to be used like a regular phone on a public switched telephone network (PSTN). You can call, place calls, transfer a call to someone else, or conduct a conference call.

At most one active call may be in progress on your phone at any time. The active call is the one that has audio associated with it. There may be multiple other calls:

- On hold
- In an “Incoming call” or “Ringing” state

This chapter provides basic operating instructions for the SoundPoint IP 550/560 phone. The topics include:

- [Placing Calls](#)
- [Answering Calls](#)
- [Ending Calls](#)
- [Redialing Numbers](#)
- [Hosting Local Conference Calls](#)
- [Using Conference Bridges](#)
- [Transferring Calls](#)
- [Forwarding Calls](#)
- [Enabling Do Not Disturb](#)
- [Placing Calls on Hold](#)
- [Returning the Last Call](#)
- [Using the Intercom](#)
- [Using the Auto Attendant](#)
- [Parking a Call](#)
- [Using the Corporate Directory](#)

- [Using Call Lists](#)
- [Using voicemail](#)
- [Recording Calls \(Virtual Office Pro Users Only\)](#)
- [Using Call Queues \(Call Queue Users Only\)](#)
- [Assigning Speed Dial Keys](#)

To customize your phone, refer to [Customizing Your Phone](#) on page 2-1.

Note

Several advanced features are available through 8x8's Virtual Office Online. For information on these features, refer to <http://www.8x8.com/Support/BusinessSupport/Documentation.aspx#a3>

If you require additional information or assistance with your new phone, contact your system administrator.



Placing Calls

You can place a call in many ways using your SoundPoint IP 550/560 phone:

- Using the handset
- Using the speakerphone
- Using the headset

You can also dial the number first—called “hot dialing”—and then choose the method you will use to speak to the other party.

You can search the call lists, the local contact directory or the corporate directory and dial from the search results page. For more information, refer to [Managing Call Lists](#) on page 2-12 and [Managing Contacts](#) on page 2-13.

During a call, you can alternate between Speakerphone Hands-Free, Headset, or Handset modes by pressing the  or  keys, or picking up the handset.

The call duration of active calls is visible within the active call window on the graphic display. In the figure below, the call to Greg Slowski has lasted 30 seconds so far.



To place a call using the handset:

>> Do the following steps in any order:

- Pick up the handset.
- Dial the number using the dial pad.

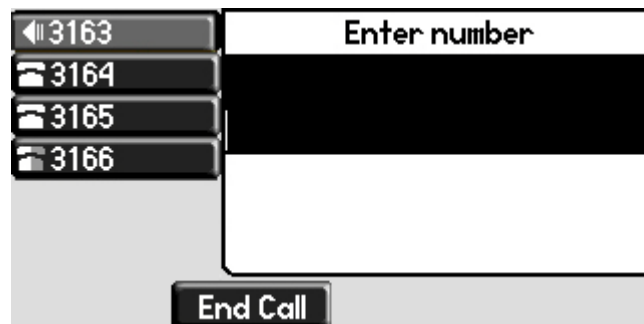

Note

You can also dial using the SIP URL or IP address. To obtain the IP address of your phone, press the **Menu** key, and then select **Status > Platform > Phone**. The IP address is listed together with other phone information. The maximum URL or IP address length is 32 characters. For example, 10.3.0.42, sip:jane@polycom.com . Press the **URL** soft key and enter the URL or IP address. Use * for "." and # for "@". Then press the **Send** soft key to complete the call. Your phone may not support SIP URL or IP address dialing. Contact your system administrator.

To place a call using Hands-Free Speakerphone mode:

Note

If "Handsfree mode disabled" appears on the graphic display after you press the speakerphone key, your system administrator has disabled the speakerphone on your phone.

>> Do one of the following:

- With the handset on-hook, press , or the **NewCall** soft key to obtain dial tone.

Dial the number using the dial pad.

- With the handset on-hook, dial the number using the dial pad.

Press , or the **Dial** soft key.

To place a call using the headset:

>> Do one of the following:

- With the optional headset connected, press  or the **NewCall** soft key to obtain dial tone.

Press .

Dial the desired number using the dial pad.

- With the optional headset connected, dial the desired number using the dial pad.

Press .

Note

To permanently enable your headset, refer to [Enabling the Headset Memory Mode](#) on page 2-6.

Answering Calls

When you are not in another call, you can answer a call in three ways:

- Using the handset
- Using the speakerphone
- Using the headset

The steps for answering an incoming call when you are in another call are different if your phone is configured for:

- A single Line Key per line



- Multiple Line Keys per line

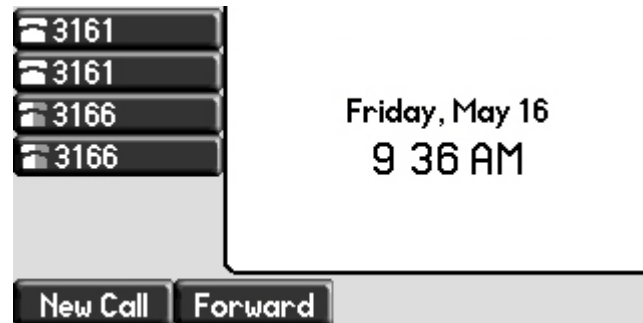

If your phone is configured with multiple call appearances, refer to [Using Multiple Call Appearances](#) on page 4-1 for instructions on how to answer a call.

Note

You can ignore incoming calls by pressing the **Reject** soft key (for private lines) or the **Do Not Disturb** key. The Do Not Disturb mode stays active when the call ends and remains active until you press the **Do Not Disturb** key again.

You can forward incoming calls by pressing the **Forward** soft key. For more information, refer to [To forward an incoming call to another party](#): on page 3-17.

When your phone is configured with a silent ring, press the ringing Line key or the **Answer** soft key to answer the call. If your handset is off-hook, the call is routed to the handset. If your handset is on-hook, the call is routed to the speaker.

Answering When Not in Another Call

In all cases, the active call will appear on the graphic display showing call duration and destination.



To answer a call using the handset:

>> Pick up the handset.

To answer a call using Hands-Free Speakerphone mode:**Note**

If “Handsfree mode disabled” appears on the graphic display after you press the speakerphone key, your system administrator has disabled the speakerphone on your phone.

>> Do one of the following:

- Press .
- With the handset on-hook, press  (next to the flashing green status indicator).
- Press the **Answer** soft key.

To answer a call using the headset:**>> Press .**

If Headset Memory Mode is activated, press  or the **Answer** soft key.

Answering When in Another Call

If you have an active call, and an incoming call arrives on the same line, do one of the following:

- If your phone is configured for a single Line Key per line:
 - You may hear a call waiting tone, and you will see the second call appearance. Caller information for the incoming call appears on the graphic display.
- If your phone is configured for multiple Line Keys per line:
 - You may hear a call waiting tone, the second Line Key indicator fast flashes green, and an incoming call icon appears. Caller information for the second Line Key appears on the bottom line of the graphic display.
- If your phone is configured for shared lines:
 - You may hear a call waiting tone, the second Line Key indicator will fast flash green, and an incoming call icon appears on the second Line Key.

Note

If your phone is configured for shared lines, the **Reject** soft key is replaced by a **Silence** soft key and there is no **Forward** soft key. To stop the incoming call from ringing, press the **Silence** soft key.

To answer an incoming call on a line configured for a single Line Key:

>> Do one of the following:

- Press  or the **Hold** soft key to put the original call on hold.

The incoming call is answered.

- Press  to access the new call.

Press the **Answer** soft key.

The original call is placed on hold.

Note

Incoming calls may be forwarded by pressing the **Forward** soft key. For more information, refer to [To forward an incoming call to another party](#): on page 3-17.

To answer an incoming call on a line configured for multiple Line Keys:

>> Do one of the following:

- Press  next the flashing green indicator.

The first call is placed on hold and the second call becomes the active call.

- Press  or the **Hold** soft key to place the original call on hold.

Press the **Answer** soft key.

Note

Incoming calls may be forwarded by pressing the **Forward** soft key. For more information, refer to [To forward an incoming call to another party](#): on page 3-17.

To answer an incoming call on a shared line:



1. Answer the incoming call.
2. Press  or the **Hold** soft key.

Anyone on another phone configured to use the same shared line may take the call by selecting the Line Key associated with the call on hold (represented by a flashing red LED).

Ending Calls

To end a call:

>> Do one of the following:

- If you are using the handset, press the **EndCall** soft key or replace the handset.
- If you are using a headset, press .
- If you are using the speakerphone, press .

Redialing Numbers

To redial the last call placed from your phone:

>> Press .

A call to your last placed call is attempted.



To redial a previously placed call, refer to [Managing Call Lists](#) on page 2-12.

Hosting Local Conference Calls

You can create a conference with other parties using the phone's local conference feature. You can create a conference at any time between an active call and a call on hold (on the same or another line) by pressing the **Join** soft key. The conference management feature allows you to view all parties in a conference call. From the Manage Conference page, you can add, hold, remove, and mute specific conference parties.

Note

The conference management feature is an optional feature and may not be supported on your particular system. For more information, contact your system administrator.

This section provides the following step-by-step instructions:

- [Setting Up Conference Calls](#)
- [Ending Conference Calls](#)

Setting Up Conference Calls

To set up a conference call:

1. Call the first party.

Note

You can either dial the phone number directly or search for the number in the Contact Directory or Call Lists. For more information, refer to [Placing Calls](#) on page 3-2, [Searching for Contacts](#) on page 2-19, or [Managing Call Lists](#) on page 2-12.

2. Press  or the **Confrnc** soft key to create a new call.

The active call is placed on hold.

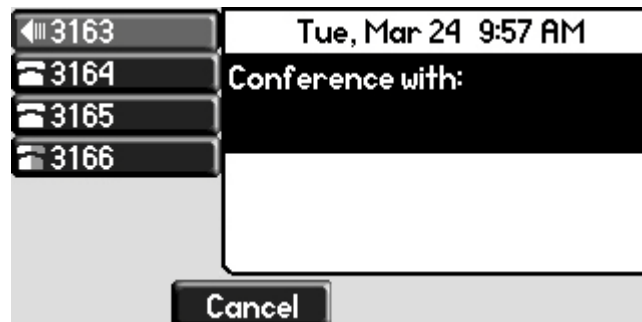
**Note**

If configured for single key-press conferences, all conference participants hear the dial tone and ringback when the conference host places a call to a new party.

3. Call the second party.

4. When the second party answers, press **Conference** or the **Confnc** soft key again to join all parties in the conference.

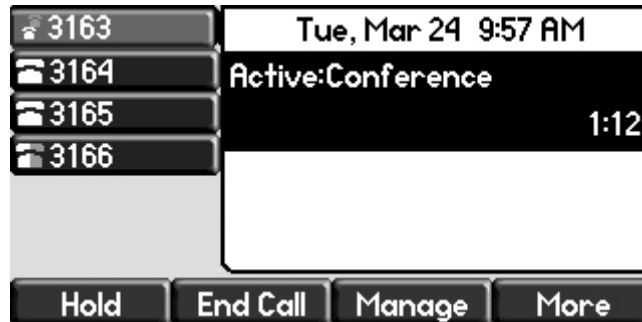
**Note**

If configured for single key-press conferences, you do not need to press the **Confnc** soft key again.

5. Press **Conference** or the **Confnc** soft key to add another party to the conference.

The first and second party are put on hold.

Note

If configured for single key-press conferences, all conference participants hear the dial tone and ringback when the conference host places a call to a new party.

6. Call the third party.
7. After the third party answers, press **Conference** or the **Confnc** soft key again to join all parties in the conference.

Note

If configured for single key-press conferences, you do not need to press the **Confnc** key again.

A conference similar to this one will now exist.

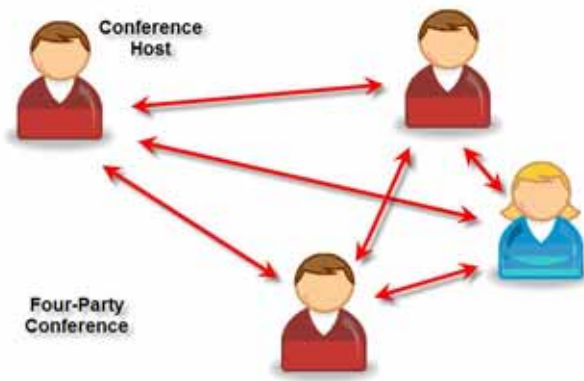

8. Repeat steps 5 to 7 until you have added all intended parties.

Splitting Conference Calls

To split a conference call:

- >> From the Active Conference page, press the **More** soft key, and then the **Split** soft key to split the conference.

All calls are split into individual calls and put on hold.

Ending Conference Calls

To end a conference call:

- >> From the Active Conference page, press the **EndCall** soft key or hang up. The other parties will continue to be connected.

Using Conference Bridges

A key business tool, the conference bridge allows users with an extension and voicemail passwords to schedule and manage conference calls.

Basic functionality includes the ability to create and log into conference bridges. There are also administrator modes that allow calling out and dropping parties from the bridge.

Conference bridge supports up to 20 connected callers. An unlimited number of conference bridges can be in session at the same time.

To call into a conference bridge:

Internal:

1. Press the **ConfServ** softkey.
2. Follow the Conference Bridge voice prompts.

External:

1. Call direct to DID to Conference Bridge (only if a DID is assigned to Conference Bridge).

2. Call in Auto Attendant and select Menu Option that is assigned to Conference Bridge.* (e.g. Option 4 > Conference Bridge)

Conference Menu Options

Enter a Conference - (Option 1):

1. Enter your extension then press #.
2. Enter conference ID then press #.
3. Please record first and last name then press #.

Create a Conference - (Option 2):

1. Enter your extension then press #.
2. Enter your password then press #. (Voicemail Password)
 - Create a conference that expires in 2 weeks press **1**
 - Create a non expiring conference press **2**
 - Create a conference with a custom expiration date press **3**

Delete Existing Conference - (Option 3):

1. Enter your extension then press #.
2. Enter your password then press #. (Voicemail Password)
3. Enter the conference ID you want to delete then press #.

Transferring Calls

A call can be transferred in one of three ways:

- Announced transfer—The party to whom you want to transfer the call answers their phone before you transfer the call or hang up. You can consult with them before completing the transfer.
 - Refer to [Performing an Announced Transfer](#) on page 3-13.
- Blind transfer—The call is automatically transferred after you dial the number of the party to whom you want to transfer the call.
 - Refer to [Performing a Blind Transfer](#) on page 3-14.
- Attended transfer—The parties are automatically connected to each other after you exit the conference.

- Set up a conference call and then end your participation. For more information, refer to [Hosting Local Conference Calls](#) on page 3-8.

Performing an Announced Transfer

To transfer a call:

1. During a call, press the  or the **Trnsfer** soft key.
The active call is placed on hold.

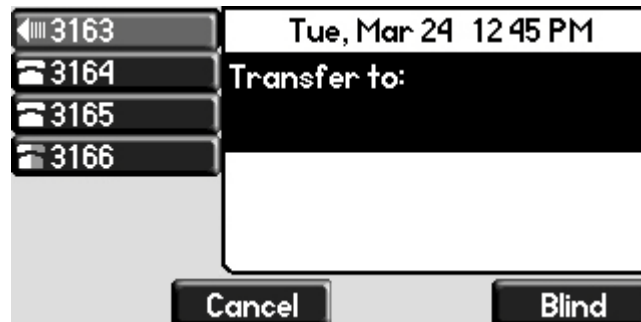

2. Do one of the following:
 - Enter the number to which you want to transfer the call.
 - Refer to [Placing Calls](#) on page 3-2.
3. As soon as you hear the ring-back sound or after the party answers (and you speak to the party), press  or the **Trnsfer** soft key.



You can talk privately to the party to which you are transferring the call before the transfer is completed.

If you are using a handset, the transfer can be completed by putting the handset on the cradle.

You can cancel the transfer before the call connects by pressing the **Cancel** soft key.

Performing a Blind Transfer

To perform a blind transfer:

1. During a call, press  or the **Transfer** soft key.
2. Press the **Blind** soft key.

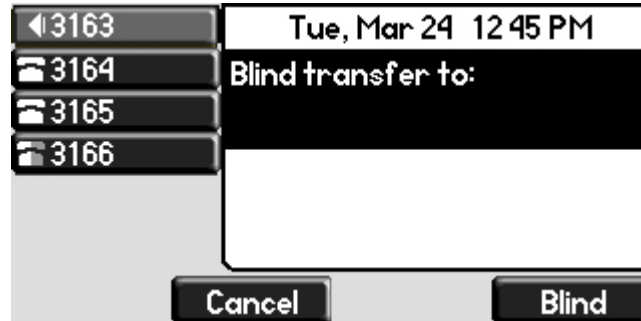

3. Do one of the following steps:
 - Enter the number to which you want to transfer the call.
 - Refer to [Placing Calls](#) on page 3-2.

At this point, the call is connected to the number to which you are transferring them.

Forwarding Calls

You can configure your phone so that all incoming calls are forwarded to another party. You can also forward calls while your phone rings.

All incoming calls can be forwarded to another party while Do Not Disturb is enabled on your phone. For more information, contact your system administrator.

The Polycom 550/560 phone offers two methods of call forwarding:

- [Online Call Forwarding](#)
- [Phone-based Call Forwarding](#)

Note

8x8 recommends using online call forwarding instead of phone-based call forwarding so that your call forwarding instructions are stored online instead of on your phone. If you set your call forwarding rules on your phone, they will not be in effect if your phone is disconnected from an Internet connection.

Online Call Forwarding

To enable online call forwarding:

1. Log on to your Virtual Office Online dashboard at <http://virtualoffice.8x8.com>
2. Select the **Settings** button, and then select the **My Rules** tab.
3. Update your Call Forwarding Rules and press **Save**.

You can return to Virtual Office Online at any time to update your Call Forwarding Rules.

Phone-based Call Forwarding

Static Forwarding

To forward all incoming calls to another party:

1. From the idle display, press the **Forward** soft key.

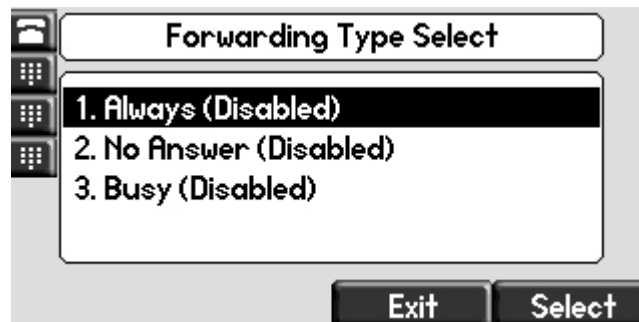

2. (Optional) If multiple lines are configured on your phone, select the line to forward from the list using \triangle and ∇ .
3. Using \triangle and ∇ , select the forwarding type you want to change, and then press the **Select** soft key. The options are:
 - **Always**—To forward all incoming calls
 - **No Answer**—To forward unanswered incoming calls
 - **Busy**—To forward calls that arrive when you are already in a call
4. Depending on your selection:

- a If you selected **Always**, enter a number to forward all future incoming calls to.

- b If you selected **No Answer**, enter a number to forward all unanswered incoming calls to and how many rings to wait before forwarding (one ring is approximately six seconds). A value of 2 is recommended.

- c If you selected **Busy**, enter a number to forward all future incoming calls to when you are already in another call.





Note

You can also enter the SIP URL or IP address. For more information on using a SIP URL or IP address, refer to [Placing Calls](#) on page 3-2

5. Select the **Enable** soft key to confirm call forwarding.

A moving arrow appears on the line label to confirm call forwarding is enabled.

To disable call forwarding:

1. From the idle display, press the **Forward** soft key.
2. (Optional) If multiple lines are configured on your phone, select the line to forward from the list using  and .
3. Using  and , select the forwarding type you want to change and then press the **Select** soft key.
4. Press the **Disable** soft key.

The idle display returns and the regular icon appears as the line indicator.

Dynamic Forwarding**To forward an incoming call to another party:**

1. When the phone rings, press the **Forward** soft key.
2. Enter a number to forward the incoming call to.
3. Press the **Enable** soft key.

The incoming call is forwarded to the other party. If call forwarding is disabled, all future calls will not be forwarded and forwarding will remain disabled.

Enabling Do Not Disturb

To prevent the phone ringing (from incoming calls), you can select Do Not Disturb.

Note

This feature is local to the phone, and may be overridden by call server settings. For more information, contact your system administrator.

To enable Do Not Disturb:

>> Press **Do Not Disturb**.

A flashing icon and text on the graphic display indicate that Do Not Disturb is enabled.

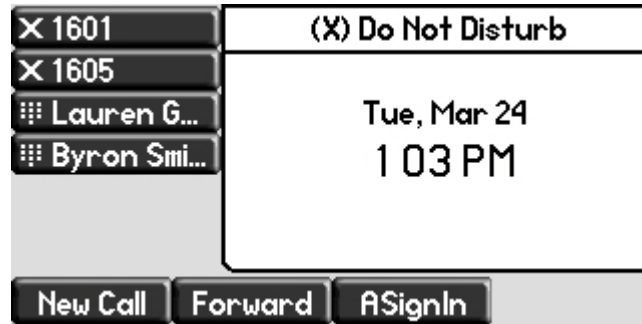

Calls received while Do Not Disturb is enabled are logged in the Missed Calls list unless configured to be forwarded to another party by your system administrator.

To disable Do Not Disturb:

>> Press **Do Not Disturb** again.

Multiple Lines and Do Not Disturb

If multiple lines are configured on your phone, Do Not Disturb can be set on a line-by-line basis from the menu using \triangle and ∇ . For more information, contact your system administrator. When Do Not Disturb is enabled for a particular line, a flashing "X" displays beside the line indicator.

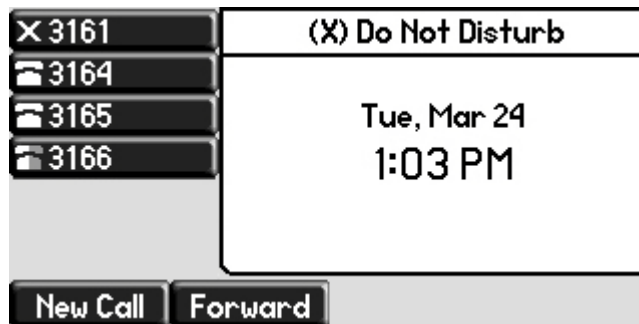

Placing Calls on Hold

During a call, press  or the **Hold** soft key. The hold icon will display on the line key label.





Press  again or the **Resume** soft key to retrieve the call. The registered line icon appears as the line indicator.

Note

The Hold feature typically generates music or a beeping tone. Therefore, avoid putting a conference call on hold.

Multiple Calls on Hold

If multiple calls are on hold on a single Line Key, use  and  to switch between the calls, and then press the **Resume** soft key to retrieve the desired call.



If more than two calls are on hold on a single Line Key, an indication appears on the graphic display, for example “2/3”, indicating that this is the second call out of three calls.

If calls are on hold on more than one Line Key, you can view the details of the calls on any Line Key by pressing and holding the Line Key for more than two seconds. If a Line Key is depressed for less than one second, the first call on hold on that Line Key will be retrieved.

Returning the Last Call

Last Call Return (LCR) enables you to automatically call back the last incoming call without having to dial the number.

To call back the last incoming call:

1. Press the **More** soft key, then the **LCR** soft key.
2. You can pick up the handset first, then press **LCR** to place the call on your handset

Using the Intercom

You can use the **Intercom** key to automatically connect with a remote extension.

To automatically connect with a remote extension:

1. Press the **Intercom** soft key.
2. Dial the number you wish to Intercom to and then press the Enter soft key.

If you are receiving an intercom call, the phone rings, then automatically connects to your speakerphone.

Using the Auto Attendant

To access the Auto Attendant:

1. Press the **AA** softkey. (Press the **More** softkey if the **AA** softkey is hidden.)
2. Follow Auto Attendant voice prompts.

Parking a Call

- During a call, press the **Park** soft key. A recording will tell you which extension the call is parked on (your other party is placed on hold until the parked call is picked up).
- To pick up a parked call, just dial the extension the call is parked at.

Using the Corporate Directory

To use the Corporate Directory to make a call:





1. Press  and select **Applications**, then select **Apps Home**, then **Corporate Directory Listing**.
2. Browse up and down the directory list and select the person you wish to call (speed dial).

For long directories, you can search for a user in the directory and then select their name to speed dial them.

To search an extensive Corporate Directory:

1. Press  and select **Applications**, then select **Apps Home**, then **Corporate Directory Search**.
2. Input name, extension, or other data into the search field, then scroll down and select **Search**.
3. Select the matching entry to speed dial the user (or select **Back** to do a new search).

Using Call Lists

From the idle screen, press  for Speed Dial,  for Received Calls,  for Missed Calls, or  for Placed Calls.

Or, press  then select **Call Lists**. Choose **Missed Calls**, **Received Calls**, or **Placed Calls**. Information on respective calls will be displayed.

From this screen, choose the appropriate soft key:

1. **Edit** to amend the contact number before dialing.
2. **Dial** to place the call.

Or press **More**, then:

1. **Info** to view detailed call information.
2. **Save** to store the contact to the Contact Directory.
3. **Clear** to delete the call from the list.

Press **Back** and **Exit** soft keys to return to the idle display.

Using voicemail

Note

voicemail is an optional feature configured on the call server and may not be supported on your particular system. For more information, contact your system administrator.

Screen options may vary with your application. voicemail may be accessible with a single key press. Contact your system administrator about this option.

You can access voicemail messages from your phone. Your voicemail is saved in a centralized location.

Your phone indicates the presence of new voicemail messages by a flashing Message Waiting Indicator LED on the front of the phone and a visual notification on the screen. If your phone has multiple lines, an individual line indicator icon indicates voicemail messages on that line.

A stutter dial tone in place of normal dial tone indicates that one or more voice messages are waiting at the message center.

To listen to voice messages:

1. Press .

If multiple lines are configured on your phone, select the line to retrieve messages from.

2. Follow voice or visual prompts on the screen to retrieve your messages.

To transfer a call to voicemail:

1. During a call, select the **XferVM** soft key.
2. Enter the extension of the person you want to transfer the caller to.
3. The caller is transferred directly to the voicemail box at that extension.

Recording Calls (Virtual Office Pro Users Only)

Call Record On/Off is available to Virtual Office Pro users when the Call Recording feature is set to record calls On Demand.

To turn on Call Recording during a call:

>> Press the **More** soft key to find the **CallRecrd** soft key.

You will see a "Recording is On" confirmation message on the phone screen.

To turn Call Recording off:

>> Press the **Exit** soft key, then press the **More** softkey to find the **CallRecrd** softkey again.

Once you press the CallRecrd softkey, you will see a "Recording is Off" confirmation message.

Using Call Queues (Call Queue Users Only)

Phones on 8x8 Call Queues can log in and out of Call Queues if the Call Queue Admin has granted log in/out permission to the user.

To enter or exit a Call Queue:

1. Press  and select **Applications > Apps Home** (or if you just recently used Call Queue, you can select **Apps Continue**).
2. Select **Call Queues > Log In All** to enter all your Call Queues (or **Log Out** to exit your Call Queues).

If you are not a member of a Call Queue set up by your administrator, you will get a message that you do not belong to any Call Queues.

Assigning Speed Dial Keys

You can associate contacts with Line Keys for single touch dialing of frequently used numbers. Speed Dial entries are consecutively placed next to assigned Line Keys on the phone. When a new entry is added to the Contact Directory, it is automatically assigned the next available speed dial index and the next available line key.



In the figure below, the phone has one line key, and three available speed dial keys (assigned to Byron, Lauren, and Andrew). To dial Byron, Lauren, or Andrew, press the associated line key.





Note

To quickly access a list of speed dial index numbers, press the **Up Arrow** key from the idle screen. To speed dial a contact, press the **Up Arrow** key followed by the contact's speed dial index. For example, if Joan's speed dial index is 55, pressing the **Up Arrow** key followed by **55** will place a call to Joan.

To add or edit a speed dial index for an existing contact:

1. Press .
2. Select **Contact Directory**.
3. Use  and  to highlight the contact.
You can also use the * key to page up and the # key to page down.
4. Press the **Edit** soft key.



5. Do one of the following:
 - Enter the next available speed dial index.
 - Delete the existing speed dial index by using  followed by , and then enter a new speed dial index.

Valid speed dial index values are from 1 to 9999. If you enter a speed dial index that already exists, “Speed dial index already exists” appears. If you enter an invalid value, “Speed dial index invalid” appears.

6. Press the **Save** or **Cancel** soft keys to accept or cancel changes.
7. Press  to return to the idle display.

To assign a new speed dial key:

1. Press and hold an unassigned .

A new empty entry in the contact directory is automatically opened allowing contact information to be added.
2. Press the **More** soft key, and then press the **Add** soft key.
3. (Optional.) Enter contact information.

Use the **1/A/a** soft key to select between numeric and upper/lower case alphanumeric modes.

Use the **Encoding** soft key to access special characters in other languages.
4. Enter a contact number.

The number must be unique (not already in the directory).
5. Change the Speed Dial Index field.

The index can be any value between the next available index value and the maximum (value of 9999).



Polycom recommends that you assign speed dial index values consecutively. For example, if you assign the third Line Key to the speed dial index value “2”, assign the fourth Line Key to the speed dial index value “3”.

6. Press the **Save** or **Cancel** soft keys to accept or cancel changes.
7. Press  to return to the idle display.

Troubleshooting Your Phone

This chapter contains general troubleshooting information to help you solve any problems you might encounter when you use your SoundPoint IP 550/560 phone. The tables in this chapter list possible trouble symptoms, the likely causes of these problems, and the recommended corrective actions to take.

- [Power and Startup](#)
- [Controls](#)
- [Access to Screens and Systems](#)
- [Calling](#)
- [Displays](#)
- [Audio](#)

To obtain more detailed troubleshooting information, you can access certain menus on your phone that test your phone hardware. For more information, see [Testing Phone Hardware](#) on page 4-9.

If you require additional assistance, contact your system administrator.

Power and Startup

Symptom	Problem	Corrective Action
There are power issues.	The SoundPoint IP 550/560 phone has no power.	<p>Do one of the following:</p> <ul style="list-style-type: none"> • Verify that no lights appear on the phone when it is powered up. • Check if the phone is properly plugged into a functional AC outlet. • Make sure that the phone isn't plugged into a plug controlled by a light switch that is off. • If the phone is plugged into a power strip, try plugging it directly into a wall outlet instead. • Try the phone in another room where the electricity is known to be working on a particular outlet. • If using PoE, the power supply voltage may be too high or too low.

Controls

Symptom	Problem	Corrective Action
<p>The dial pad does not work.</p>	<p>The dial pad on the SoundPoint IP 550/560 phone does not respond.</p>	<p>Do one of the following:</p> <ul style="list-style-type: none"> • Check for a response from other feature keys or from the dial pad. • Place a call to the phone from a known working telephone. Check for display updates. • Check if the LAN port is active or inactive. Press the Menu key, and then select Status > Network > Ethernet. From the Ethernet page, scroll to the LAN port field and verify that it is active. • Check the termination at the switch or hub end of the network LAN cable. Ensure that the switch/hub port connected to the telephone is operational (if not accessible, contact your system administrator). • Before restarting your phone, contact your system administrator. Your system administrator may want to troubleshoot your phone in more detail before restarting the phone and losing current status information.

Access to Screens and Systems

Symptom	Problem	Corrective Action
There is no response when you press a feature key.	The SoundPoint IP 550/560 phone is not in an active state.	<p>Do one of the following:</p> <ul style="list-style-type: none"> • Press the keys more slowly. • Check with your system administrator to see if the key has been mapped to a different function or is disabled. • Place a call to the phone to check that inbound call display and ringing is normal. If successful, try to press feature keys within the call to access the Main Menu, for example. • To confirm that the line is active, press the Menu key, and then select Status > Lines > Line Information. From the Line Information page, verify that your phone line is registered. • Reboot the phone to attempt re-registration to the call server. Contact your system administrator.
The screen shows "Network Link is Down".	The LAN cable is not properly connected.	<p>Do one of the following:</p> <ul style="list-style-type: none"> • Check termination at the switch or hub (furthest end of the cable from the phone). • Check that the switch or hub is operational (flashing link/status lights) or contact your system administrator. • Check if the LAN port is active or inactive. Press the Menu key, and then select Status > Network > Ethernet. From the Ethernet page, scroll to the LAN port field and verify that it is active. • Reboot the phone to attempt re-registration to the call server. Contact your system administrator.

Calling

Symptom	Problem	Corrective Action
There is no dial tone.	Power is not correctly applied to the SoundPoint IP 550/560 phone.	Do one of the following: <ul style="list-style-type: none"> • Check that the screen is illuminated. • Make sure the LAN cable is inserted properly at the back of the phone (try unplugging and re-inserting the cable). • If using in-line powering, have your system administrator check that the switch is supplying power to the phone.
	Dial tone is not present on one of the audio modes.	Do one of the following: <ul style="list-style-type: none"> • Switch between Handset, Headset (if present) or Hands-Free Speakerphone to see if the dial tone is present for one of audio modes. • If the dial tone exists on another audio mode, connect a different handset or headset to isolate the problem.
	The phone is not registered.	Contact your system administrator.
The phone does not ring.	Ring setting or volume is low.	Do one of the following: <ul style="list-style-type: none"> • Adjust the ringing level from the front panel using the volume up/down keys. • Check status of Handset, Headset (if connected), and Hands-Free Speakerphone.
	Outbound or inbound calling is unsuccessful.	Do one of the following: <ul style="list-style-type: none"> • Place a call to the phone under investigation. Check that the screen indicates incoming call information. • Lift the handset. Ensure the dial tone is present and place a call to another extension or number. Check that the screen changes in response.

Symptom	Problem	Corrective Action
	You turned off the ringer.	Do one of the following: <ul style="list-style-type: none"> • During an incoming call, lift the handset, press the Speakerphone key, or press the Headset key to obtain a dial tone. • Press the ringing Line Key or the Answer soft key to answer the call.
"Service Unavailable" appears on the screen.	The user pressed the New Call soft key, dialed a number with the handset on-hook, or attempted to make a call from the contact directory when the phone was not registered.	Check with your system administrator to see when your phone will be registered.
The line icon shows an unregistered line icon.	The phone line is unregistered.	Contact your system administrator.

Displays

Symptom	Problem	Corrective Action
<p>There is no display. The display is incorrect. The display has bad contrast.</p>	<p>Power is not correctly applied to the SoundPoint IP 550/560 phone.</p>	<p>Do one of the following:</p> <ul style="list-style-type: none"> • Check that the screen is illuminated. • Make sure the LAN cable is inserted properly at the back of the phone (try unplugging and re-inserting the cable). • If using Power over Ethernet (PoE), have your system administrator check that the switch is supplying power to the phone. • Use the screen capture feature. Contact your system administrator to determine if it is enabled.
	<p>The contrast needs adjustment.</p>	<p>Do one of the following:</p> <ul style="list-style-type: none"> • Refer to Changing the Display Contrast on page 2-3. • Reboot the phone to obtain a default level of contrast. • Use the screen capture feature. Contact your system administrator to determine if it is enabled.
	<p>Outbound or inbound calling is unsuccessful.</p>	<p>Do one of the following:</p> <ul style="list-style-type: none"> • Place a call to the phone under investigation. Check that the screen indicates incoming call information. • Lift the handset. Ensure the dial tone is present and place a call to another extension or number. Check that the screen changes in response. • Use the screen capture feature. Contact your system administrator to determine if it is enabled.
<p>The display flickers.</p>	<p>A certain type of older fluorescent lighting causes the display to appear to flicker.</p>	<p>Do one of the following:</p> <ul style="list-style-type: none"> • Move the SoundPoint IP 550/560 phone away from the lights. • Replace the lights. • Use the screen capture feature. Contact your system administrator to determine if it is enabled.

Audio

Symptom	Problem	Corrective Action
There is no audio on the headset.	The connections are not correct.	<p>Do one of the following:</p> <ul style="list-style-type: none"> • Ensure the headset is plugged into the jack marked Headset at the rear of the phone. • Ensure the headset amplifier (if present) is turned on and/or the volume is correctly adjusted. If the amplifier uses batteries, check that they are fully charged.
You are using a headset and the people you call hear echo.	There may be an issue with the echo cancellation feature of your headset.	<p>Do the following:</p> <ul style="list-style-type: none"> • Press the Menu key, then select Settings > Basic > Preferences > Headset > Echo Cancellation. • Using the arrow keys, select Enabled, and then press the Select soft key. • Contact your system administrator.

Testing Phone Hardware

Your system administrator may ask you to access a diagnostics menu on your phone to test your phone hardware. From the diagnostics menu, you can test your phone's microphones, speaker, handset, third-party headset (if present), keypad mappings, and LCD display. See your system administrator for instructions on how to perform these tests.

To test your phone hardware:

>> Press , and then select **Status > Diagnostics > Test Hardware > Audio Diagnostics, Keypad Diagnostics, or Display Diagnostics.**